

INSTALLATION INSTRUCTION

Wall Wash

5022

WAC
LANDSCAPE LIGHTING

WARNING

IMPORTANT: NEVER attempt to do any work without shutting off the electricity.

1. Read all instructions before installing.
2. System is intended for installation by a qualified electrician in accordance with the National Electrical Code and local regulations.
3. Place the wall switch in the "OFF" position.
4. Go to the main fuse box, or circuit breaker. Unscrew the fuse(s) or switch "OFF" the circuit breaker switch(es) that control the power to the space that you are working on.

CAUTION

- All parts must be used as indicated in these instructions. Do not substitute any parts, leave parts out, or use any parts that are worn out or broken. Failure to follow this instruction may invalidate the UL listing of this fixture.

AVERTISSEMENT

IMPORTANT : Coupez l'électricité avant TOUTE manipulation.

- Lisez toutes les instructions avant d'installer.
- Système est destiné à être installé par un électricien qualifié en conformité avec le code national de l'électricité et les règlements locaux.
- Placez l'interrupteur mural en position d'arrêt (« OFF »).
- Toujours mettre le fusible ou le disjoncteur en position arrêt dans la pièce ou des travaux électriques sont prévus

MISE EN GARDE

- Toutes les pièces doivent être utilisées tel qu'il est indiqué dans ces instructions. Ne remplacez pas les pièces, n'en laissez pas de côté et ne les utilisez pas si elles sont usées ou brisées. Le non-respect de ces instructions peut annuler l'homologation UL du luminaire.

ADVERTENCIA

IMPORTANTE: NUNCA intente hacer trabajos sin desconectar el suministro eléctrico.

- Lea y comprenda todas las instrucciones e ilustraciones por completo antes de proceder con el ensamblaje e instalación de esta lámpara.
- Sistema está diseñado para ser instalado por un electricista calificado, de acuerdo con el código eléctrico nacional y las normas locales.
- Coloque el interruptor de la pared en la posición "OFF" (APAGADO).
- Diríjase a la caja de fusibles o a la caja del interruptor de circuito principal en su hogar. Coloque el interruptor de alimentación principal en la posición "OFF" (APAGADO).

PRECAUCIÓN

- Todas las piezas deben usarse como lo indican estas instrucciones. No reemplace las piezas, no omita piezas durante la instalación ni utilice piezas gastadas o rotas. El incumplimiento de esta indicación podría invalidar la calificación UL esta lámpara.

This instruction apply to the model(s) below:

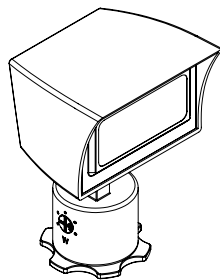

5022-30

waclighting.com
Phone (800) 526.2588
Fax (800) 526.2585

Headquarters/Eastern Distribution Center
44 Harbor Park Drive
Port Washington, NY 11050

Central Distribution Center
1600 Distribution Ct
Lithia Springs, GA 30122

Western Distribution Center
1750 Archibald Avenue
Ontario, CA 91761



MOUNTING ACCESSORIES



Outdoor Rated Wire Nut
Qty: 3pcs

Step 1: Installing the fixture on Power Stake

1. Make sure your main power is off.
2. Excavate a trench for the UF supply line cable or conduit/ conductors and the Landscape Power Stake. The Landscape Power Stake requires approximately a one (1) square foot hole to facilitate installation. The excavated should be approximately 15" deep. This will allow the hex-head set screw on the Power Stake to remain above ground when the installation is completed.
3. Turn the hex-head set screw counterclockwise to remove the Power Stake Cap from the top of the PVC Light Stake.
4. Feed the light fixtures black, white, and ground wires through the top of the Power Stake Cap. Then, thread the light fixture until it's firmly attached to the Power Stake Cap.
5. Fed the incoming supply line cable through the slanted bottom of the PVC Light Stake. Note: If you are wiring multiple light fixtures in series, also bring the second supply line cable into the PVC Light Stake.
6. Bring the supply line cable through knockout hole in the Separator Disk. If second supply line is required, carefully break-out and remove the second knockout in the Separator Disk.
7. Attached a UF connector(s) to supply line cable(s), then secure the connector(s) to the Separator Disk.
8. Using appropriate UL Listed wire connectors, splice the white wire from the light fixture to the incoming supply line cable(s) white wire(s), and the black wire from the light fixture to the incoming supply line's black wire(s). Then splice the ground wire from the light fixture to the incoming supply line cable(s) ground wire(s).

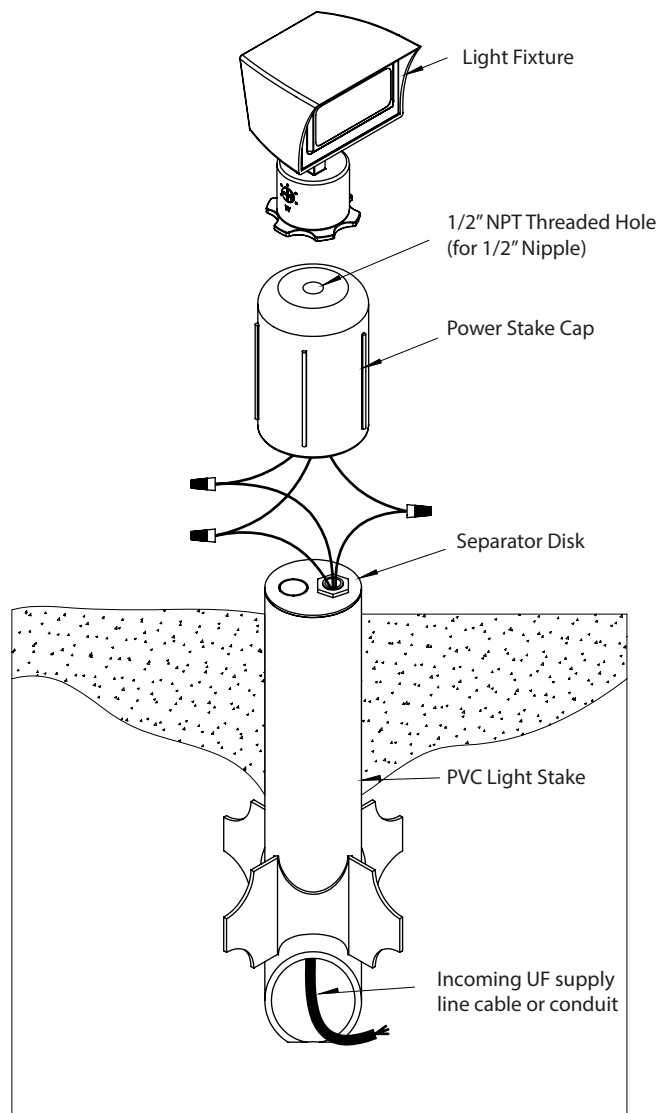

INSTALLATION INSTRUCTION

Wall Wash

5022

WAC
LANDSCAPE LIGHTING

- Place the Separator Disk squarely on top of the PVC Light Stake. Then place the Power Stake Cap with attached light fixture over the PVC Light Stake and Separator Disk. Carefully push the incoming supply line cable down into the PVC Light Stake. Tighten the hex-head screw clockwise on the Landscape Power Stake Cap.
- Lower the completely wired and assembled Landscape Power Stake into the excavated hole. Make sure that the excavated hole is approximately 15" deep to allow the hex-head set screw on the Landscape Power Stake Cap to remain above the ground.
- Back fill the soil around the Landscape Power Stake.
- Screw the fixture onto the stake provided, leading the wire from the fixture through the wire slot in the stake.
- If desired, bury your wire by digging a small trench. Close the trench by applying an inward force to both sides of the trench.
- Repeat steps for other fixtures in the same electrical circuit.
- Turn the main power supply back on and make sure the fixtures light up.

Step 2: Aiming the Fixture

- Tilting:** Loosen the joint screw and adjust the head of the fixture to the desired direction before retightening the screw.
- Loosen the mounting knob and rotate the fixture to the desired position before retightening the knob.

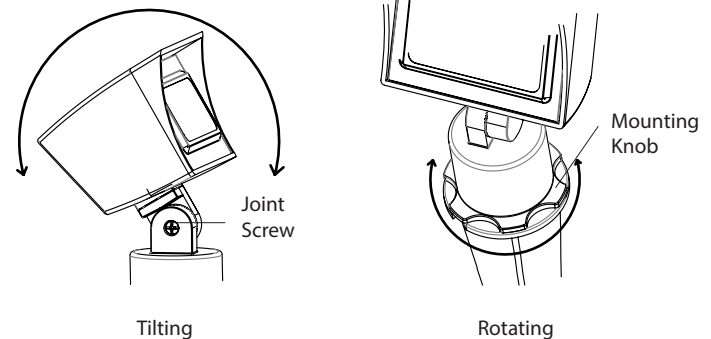

Step 2: Dimming Adjustment

- Use a Phillips head screwdriver to adjust the dimming dial.
- Rotate until the arrow on the dial is pointed at the desired wattage. The wattage may be adjusted to the pre-existing tabs or any value in between.
- The lower the wattage, the dimmer the fixture will be.
- Please refer to the yellow tag to determine the lumen output of the fixture

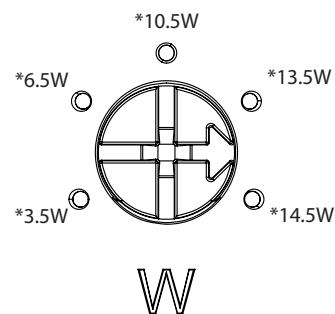

Model: 5022

*Numbers not printed
on fixture

waclighting.com
Phone (800) 526.2588
Fax (800) 526.2585

Headquarters/Eastern Distribution Center
44 Harbor Park Drive
Port Washington, NY 11050

Central Distribution Center
1600 Distribution Ct
Lithia Springs, GA 30122

Western Distribution Center
1750 Archibald Avenue
Ontario, CA 91761



INSTALLATION INSTRUCTION

Wall Wash

5022

WAC

LANDSCAPE LIGHTING

ACCESSORIES

I. Color Lens

Colored lens come in red, blue, green and amber to filter the light coming out of the fixture.

Installation: Loosen the thumbscrew and remove the shroud. Place the colored lens into the fixture and secure by replacing the shroud.

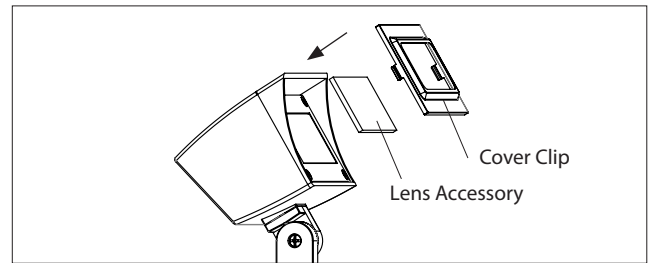

II. Surface/Wall Mount Accessory

The surface mount accessory is used to mount the fixture to soil, or a hard surface like wood or cement or as alternative to the power stake. In addition, surface mount accessory can also be used in wall mount applications.

Installation: Mount the weatherproof junction box onto the surface and run conduit. Thread the light fixture onto the mounting canopy. Connect all wires in the junction box. Then, mount the Canopy onto the junction box with screws and gasket. Make sure the whole unit is sealed properly from water.

Note: all components must be UL Listed.

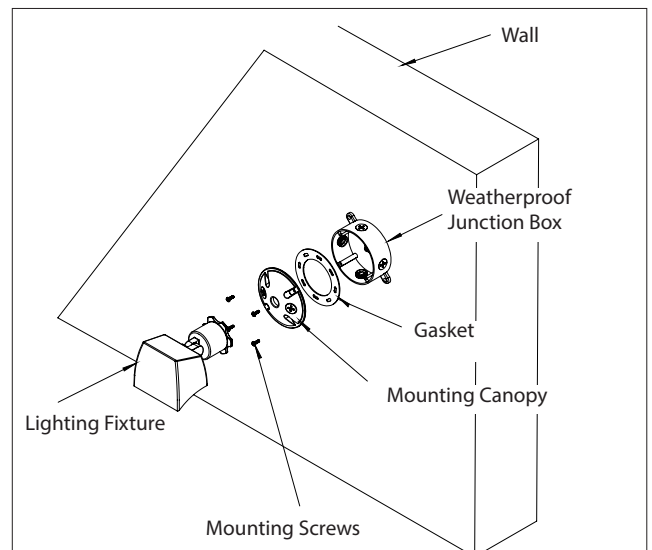
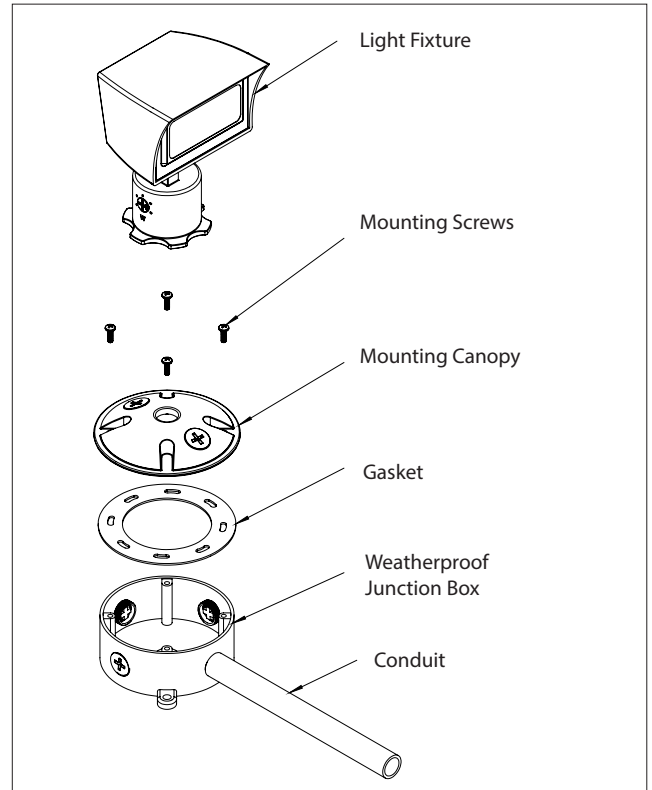

waclighting.com
Phone (800) 526.2588
Fax (800) 526.2585

Headquarters/Eastern Distribution Center
44 Harbor Park Drive
Port Washington, NY 11050

Central Distribution Center
1600 Distribution Ct
Lithia Springs, GA 30122

Western Distribution Center
1750 Archibald Avenue
Ontario, CA 91761



INSTALLATION INSTRUCTION

Wall Wash

5022

WAC
LANDSCAPE LIGHTING

ACCESSORIES

III. Tree Mount Accessory:

The tree mount accessory is a way for fixtures to be mounted on the trunk or a branch of a tree while minimizing damage to the tree.

Installation: Mark the screw-hole locations at the point of installation. Screw the provided screw bolts into the tree until the unthreaded portion of the bolt meets the surface of the tree. Screw a hex-nut onto bolt until it hits the unthreaded area. Place the tree mount bracket onto the bolts and secure using additional hex nuts. Attach light fixture and lead wire through the bracket.

Note: all components must be UL Listed.

IV. Extension Accessory

Using extension rods and rod joiners, fixtures can be mounted away from a surface in any desired direction. Rods come in 5 sizes: 4 inches, 8 inches, 12 inches, 18 inches, and 24 inches. These rods can be connected via either straight or 90 degree rod joiners.

Installation: Screw in a rod joiner into your mounting accessory. Screw an extension rod to the other side of the rod joiner. Continue to use rod joiners and extension rods until the fixture is in the desired position.

Note: all components must be UL Listed.

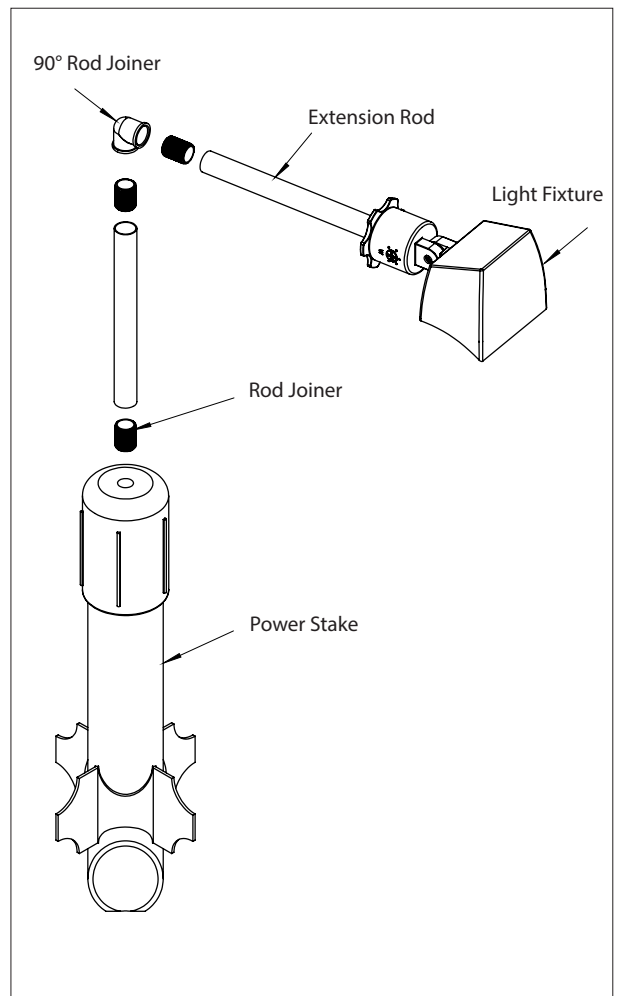
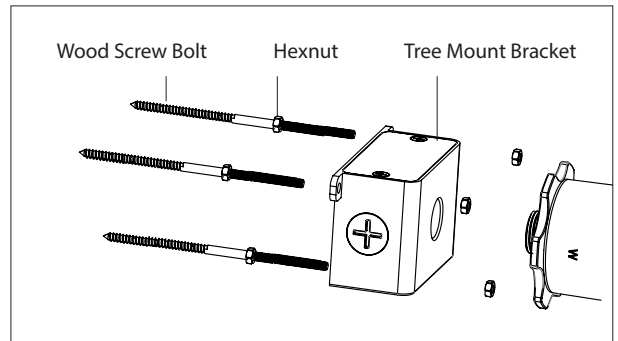

wacighting.com
Phone (800) 526.2588
Fax (800) 526.2585

Headquarters/Eastern Distribution Center
44 Harbor Park Drive
Port Washington, NY 11050

Central Distribution Center
1600 Distribution Ct
Lithia Springs, GA 30122

Western Distribution Center
1750 Archibald Avenue
Ontario, CA 91761

