

INVISILED® PRO 2

24V LED Tape Light



Fixture Type:

Catalog Number:

Project:

Location:

PRODUCT DESCRIPTION

Ideal for task or accent lighting, InvisILED Pro 2 is a high-performing and modern light system that provides flexible, eco-friendly, and dimmable illumination. Offering three different mounting options, including the 3M construction adhesive on the back for peeling and sticking, enables it to be used in cabinets, counter tops, and coves. 80,000 hours of rated life ensures longevity and a high lumens output.

FEATURES

- Can be field cut, male to male adapter required to re-use female side
- Ultra thin profile at 1/8"
- Diodes spaced evenly at 1" on center
- Minimum run length of 1'
- May be field cut every 6" at the end of a run
- Three (3) mounting method provided for different surfaces
- Specially rated for installation in the storage area of a clothes closet
- 80,000 hour rated life
- 5 year WAC Lighting product warranty

SPECIFICATIONS

- Construction:** Flexible silicone cased tape light, peel and stick 3M construction adhesive on back, indicating marks for field cutting.
- Light Source:** 12 LEDs per foot output, Runs on 24V at 4W per foot
- Operating Temp:** -4°F – 122°F (-20°C – 50°C) at relative humidity 95%
- Standards:** UL & cUL Listed for Damp Locations

ORDER NUMBER – TAPE SECTION

Model	Watts/ft	Color Temp	CRI	Lumens/ft	Title 24	Length	Qty	Tape Color
LED-TX24 4	22	2200K	90	275	No	6IN 6 inches	1	WT White
	27	2700K	90	325	Yes		1	
	30	3000K	90	300	Yes		40	
	35	3500K	90	330	Yes		1	
	45	4500K	85	330	No		1	

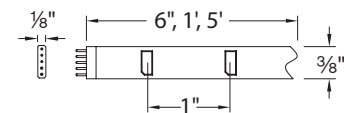

LED-TX24 ___ - ___ - **WT**

Example: **LED-TX2445-1-40-WT**

ORDER NUMBER – 5 LED "L" CONNECTOR

Model	Watts/ft	Color Temp	CRI	Lumens/ft	Title 24	Tape Color
LED-TX24 2	22	2200K	90	110	No	5L-WT White
	27	2700K	90	130	Yes	
	30	3000K	90	130	Yes	
	35	3500K	90	135	Yes	
	45	4500K	85	135	No	

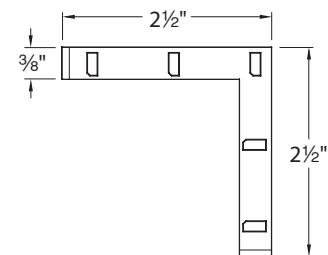

LED-TX24 ___ - **5L-WT**

Example: **LED-TX2435-5L-WT**

wacighting.com

Phone (800) 526.2588

Fax (800) 526.2585

Headquarters, East Manufacturing Facility

44 Harbor Park Drive

Port Washington, NY 11050

South East Manufacturing Facility

1600 Distribution Ct

Lithia Springs, GA 30122

Central Manufacturing Facility

1700 South J Elmer Freeway, Ste 100

Cedar Hill, TX 75104

West Manufacturing Facility

1750 S Archibald Ave





Ontario, CA 91761

INVISILED® PRO 2



24V LED Tape Light



Class 2 Power Supply (Required)

Model	Input	Output	Max Run	Dimming	Description
 EN-2460-RB2-T EN-24100-RB2-T	Remote	120VAC 120VAC	24VAC / 60W 24VAC / 96W	15' 25'	100%-5% ELV UL Class 2 output.
 PS-24DC-U60R-T PS-24DC-U96R-T	Remote	120-277VAC	24VDC / 60W 24VDC / 96W	15' 25'	100%-5% ELV, TRIAC UL Class 2 output.
 EN-24100-277-RB2-T	Remote	277VAC	24VDC / 96W	25'	100%-5% 0-10V UL Class 2 output.
 EN-2460-P-AR-T EN-24100-P-AR-T	Plug-in	120VAC 120VAC	24VAC / 60W 24VAC / 96W	15' 25'	Non Dimmable UL Class 2 output.
 EN-D24100-120-R	Wall Dimmer & Driver	120VAC	24VDC / 96W	25'	Integral UL Class 2 output.

Indoor Controller

Model	Description
 CT-6A-R2	<i>Pro, Pro2, Pro3, LITE</i> Touch Panel and Motion Sensor Includes a Touch Panel, Occupancy Sensor and a Controller. AC/DC input at 12V(60W Max) or 24V(96W Max). Connect on secondary side of driver/transformer.
 IR-96-24VACDC-WT IR-96-24VACDC-BK	<i>White Black</i> IR Sensor IR (Infrared sensor) switch works by turning the light on when it becomes unobstructed.

Smart Control

Model	Description
 CT-96-SM	InvisiLED® Smart Home Kit Transform your interiors with the InvisiLED® Smart Home Kit, designed exclusively for InvisiLED Lite, Pro, Pro 2 and Pro 3 Tape. Control your LED tape seamlessly via Wi-Fi using the MyWAC app with devices you already own, including Amazon Alexa and Google Home. Offers on/off activation and up/down dimming capability for 24VDC systems and high-output tape lighting applications. Or use DMX to control your popular control platforms. Includes a 96W 24VDC Power Supply (EN-24DC096-UNV-RB2), wireless controller (CTR-WDMX-24VDC) and a ready-to-connect lead wire with an InvisiLED Connector (LED-TC-B-2-WT)

Model	Input	Description
 LED-WCT-WT	120-230VAC	<ul style="list-style-type: none"> - Multi-scene selection - Raise/Lower, dedicated Off button - Suitable for standard single NEMA wall box Setup and configuration via MyWAC mobile application - no physical adjustment needed - cUL listed

EXAMPLE INSTALLATION FOR WIRELESS AND DMX CONTROL

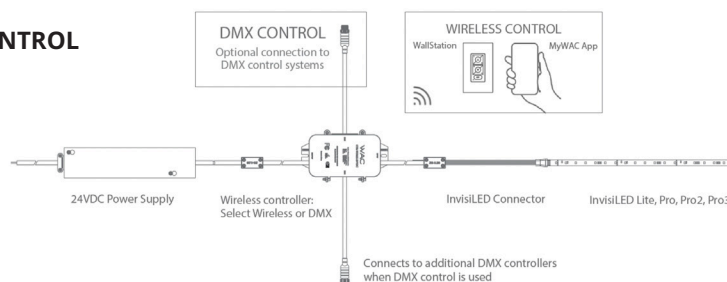

wacighting.com
 Phone (800) 526.2588
 Fax (800) 526.2585

Headquarters, East Manufacturing Facility
 44 Harbor Park Drive
 Port Washington, NY 11050

South East Manufacturing Facility
 1600 Distribution Ct
 Lithia Springs, GA 30122

Central Manufacturing Facility
 1700 South J Elmer Freeway, Ste 100
 Cedar Hill, TX 75104

West Manufacturing Facility
 1750 S Archibald Ave
 Ontario, CA 91761

INVISILED® PRO 2

24V LED Tape Light



Indoor Electrical Accessories

	Model	Dimension	Finish	Description
	LED-TC-WEXT-144	12 ft	Black	In Wall Rated Extension Cable Extends distance between a hard wired power supply or a wiring box to a tape section.
	LED-TC-WEXT-144-WT	12 ft	White	
	LED-TC-WEXT-240	20 ft	Black	
	LED-TC-WEXT-240-WT	20 ft	White	
	LED-TC-WIC-144	12 ft	Black	In Wall Rated Joiner Cable Connects tape sections. 2 female ends. 1 male to male connector included.
	LED-TC-WIC-144-WT	12 ft	White	
	LED-TC-WIC-240	20 ft	Black	
	LED-TC-WIC-240-WT	20 ft	White	
	LED-TC-P-2	2 ft	Black	Lead Wire Alternative lengths for plug-in power supplies.
	LED-TC-P-2-WT	2 ft	White	
	LED-TC-P-12	12 ft	Black	
	LED-TC-P-12-WT	12 ft	White	
	LED-TC-EXT-144	12 ft	Black	Extension Cable Extends distance between a hard wired power supply or a wiring box to a tape section.
	LED-TC-EXT-144-WT	12 ft	White	
	LED-TC-B-2	L: 1½ in W: ¾ in H: 7/8 in	Black	Low Voltage Wiring Box With Feed Neatly houses connections for up to two wires with 12" female feed.
	LED-TC-B-2-WT		White	
	LED-T-B	L: 1½ in W: ¾ in H: 7/8 in	White	Low Voltage Wiring Box Neatly houses connections for up to two wires.
	TB-S	L: 6¼ in W: 1½ in H: 1¼ in	White	Wiring Box With Switch Use when spanning a large gap in a system layout without leaving exposed wiring. Optional switch included.

Compatible with Pro, Pro2, Pro3

	Model	Dimension	Finish	Description
	LED-TC-IC2	2 in	Black	Joiner Cable Connects tape sections.
	LED-TC-IC2-WT	2 in	White	
	LED-TC-IC6	6 in	Black	
	LED-TC-IC6-WT	6 in	White	
	LED-TC-IC12	12 in	Black	
	LED-TC-IC12-WT	12 in	White	
	LED-TC-IC36	36 in	Black	
	LED-TC-IC36-WT	36 in	White	
	LED-TC-IC72	72 in	Black	
	LED-TC-IC72-WT	72 in	White	



LED-TC-MM

50 Qty

Black

Connector
Male to male connector.

Compatible with Pro, Pro2, Pro3, LITE. Change directionality of tape runs and reuse cut ends of tape.

	Model	Finish	Description
	LED-TC-Y	Black	3-Way "Y" Connector Connects tape sections.
	LED-TC-Y-WT	White	
	LED-TC-X	Black	4-Way "X" Connector Connects tape sections.
	LED-TC-X-WT	White	
	LED-TC-L	Black	"L" Connector Connects tape sections.
	LED-TC-L-WT	White	
	LED-TC-EC	Black	End Cap 1 cut and 1 male end cap.
	LED-TC-EC-WT	White	

Compatible with Pro, Pro2, Pro3, LITE.

	Model	Dimension	Finish	Description
	T24-OD-SW60	5 ft	Black	DMX Joiner Cable - Satellite Connect between CTR-WDMX-24VDC Master to Satellite
	T24-OD-SW120	10 ft		
	T24-OD-MW60	5 ft	Black	DMX Joiner Cable Connect between DMX Universe to CTR-WDMX-24VDC
	T24-OD-MW120	10 ft		

wacighting.com
Phone (800) 526.2588
Fax (800) 526.2585

Headquarters, East Manufacturing Facility
44 Harbor Park Drive
Port Washington, NY 11050

South East Manufacturing Facility
1600 Distribution Ct
Lithia Springs, GA 30122

Central Manufacturing Facility
1700 South J Elmer Freeway, Ste 100
Cedar Hill, TX 75104

West Manufacturing Facility
1750 S Archibald Ave
Ontario, CA 91761

INVISILED® PRO 2

Indoor Aluminum Channels

WAC



Aluminum Channel **LED-T-CH** 5 feet
Additional End Caps **LED-T-CH-EC** 2 pcs

*Diffuses light from InvisiLED® tape
 Includes a diffuser, two end caps, and five screws*



Deep Aluminum Channel **LED-T-CH1** 5 feet
Additional End Caps **LED-T-CH1-EC** 2 pcs

*Eliminates visible hot spots
 Includes a diffuser, two end caps, and five screws*



45° Angled Aluminum Channel **LED-T-CH2** 5 feet
Additional End Caps **LED-T-CH2-EC** 2 pcs

Includes a diffuser, two end caps, and five screws



Deep Aluminum Channel - Flood 54° Beam Angle **LED-T-CH3-FL** 5 feet
Additional End Caps **LED-T-CH1-EC** 2 pcs

Eliminates visible hot spots / 54° beam angles



Deep Aluminum Channel - Spot 9° Beam Angle **LED-T-CH3-SP** 5 feet
Additional End Caps **LED-T-CH1-EC** 2 pcs

Eliminates visible hot spots / 9° beam angles



Deep Aluminum Channel - Wide Flood 84° Beam Angle **LED-T-CH3-WF** 5 feet
Additional End Caps **LED-T-CH1-EC** 2 pcs

Eliminates visible hot spots / 84° beam angles



Fixed Angle Channel Clip **LED-T-CL3-PT**

Includes 2 pieces, 4 screws. Use to mount Aluminum Channel.

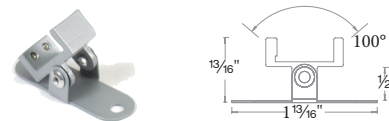

Adjustable Channel Clip **LED-T-CL2-PT**

*Includes 2 pieces, 4 screws. Used to mount Aluminum Channel.
 Adjusts 50° from center either way.*

INDOOR MOUNTING ACCESSORIES



Aluminum Retrofit Channel **LED-T-RC** 3 feet

Can be bent to create fixed curves or used as a glare shield



Clip **LED-T-CL** **Curve Clip** **LED-T-CL1**

*For surfaces that are difficult to adhere.
 Includes: 10 pcs plastic clips and 10 pcs screws.
 Compatible with InvisiLED LITE, PRO,
 PRO2 and PRO3 only.*

*Clips to hold indoor InvisiLED tapes
 sections. Includes: 10 pcs plastic clips and
 10 pcs screws. Compatible with InvisiLED
 LITE, PRO, PRO2 and PRO3 only.*

wacighting.com	Headquarters, East Manufacturing Facility	South East Manufacturing Facility	Central Manufacturing Facility	West Manufacturing Facility
Phone (800) 526.2588	44 Harbor Park Drive	1600 Distribution Ct	1700 South J Elmer Freeway, Ste 100	1750 S Archibald Ave
Fax (800) 526.2585	Port Washington, NY 11050	Lithia Springs, GA 30122	Cedar Hill, TX 75104	Ontario, CA 91761

INVISILED® PRO 2

Symmetrical Recessed Channel

WAC

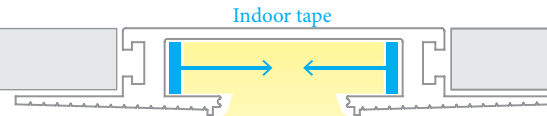

- Installs within $\frac{5}{8}$ " drywall depth
- Linear channel can be field cut
- Accommodates either one or two runs of indoor tape
- Includes a translucent white acrylic diffuser
- Dense foam insert to be removed in installation after spackling

8ft Linear Channel

LED-T-RCH1-WT

- Includes: 1 diffuser
- 8 perforated metal sheets

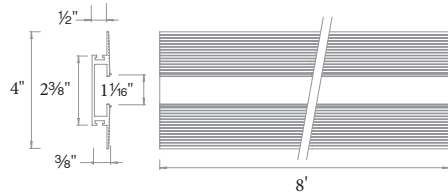

Power Feed

LED-T-RBOX1-WT

- The end cap may be placed on either side
- Hanger bars may be installed on any side of the wiring box
- Kit includes:

- 1 wiring box
- 2 hanger bars
- 4 five-pin adapters
- 2 end caps
- 1 diffuser

- 2 channel connectors
- 1 counter sink drill bit
- 1 drill bit
- 1 installation tool

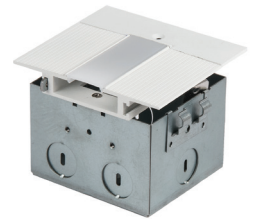
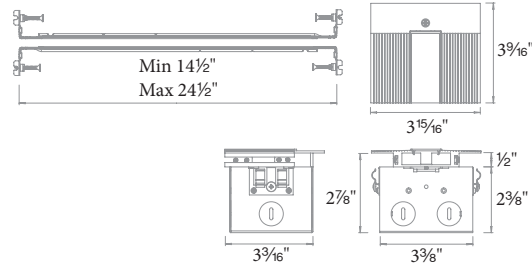

Lateral Corner

LED-T-CTC1-WT

- Includes: Diffuser
- 2 channel connectors
- 2 perforated metal sheets

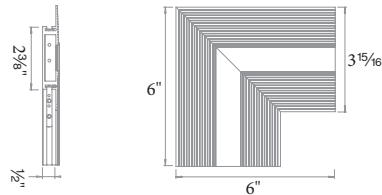

Perpendicular Corner

LED-T-WTC1-WT

- Transitions between walls or wall to ceiling
- Includes: Diffuser
- 2 channel connectors
- 2 perforated metal sheets

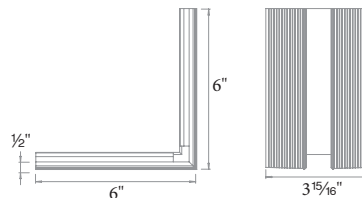

Outside Corner

LED-T-WTW1-WT

- Transitions around columns, bump outs, or soffits
- Includes: Diffuser
- 2 channel connectors
- 2 perforated metal sheets

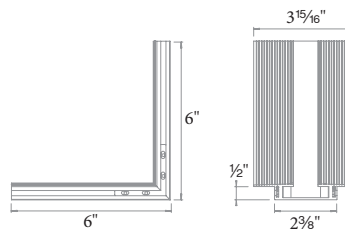

wacighting.com

Phone (800) 526.2588

Fax (800) 526.2585

Headquarters, East Manufacturing Facility

44 Harbor Park Drive

Port Washington, NY 11050

South East Manufacturing Facility

1600 Distribution Ct

Lithia Springs, GA 30122

Central Manufacturing Facility

1700 South J Elmer Freeway, Ste 100

Cedar Hill, TX 75104

West Manufacturing Facility

1750 S Archibald Ave

Ontario, CA 91761

INVISILED® PRO 2

Asymmetrical Recessed Channel

WAC



Installs within 5/8" drywall depth
 Linear channel can be field cut
 Accommodates one run of indoor tape
 Dense foam insert to be removed in installation after spackling
 Recommended installation within 15 inches of surface to be illuminated

8ft Linear Channel **LED-T-RCH2-WT**

Includes: 8 perforated metal sheets
 2 channel connectors

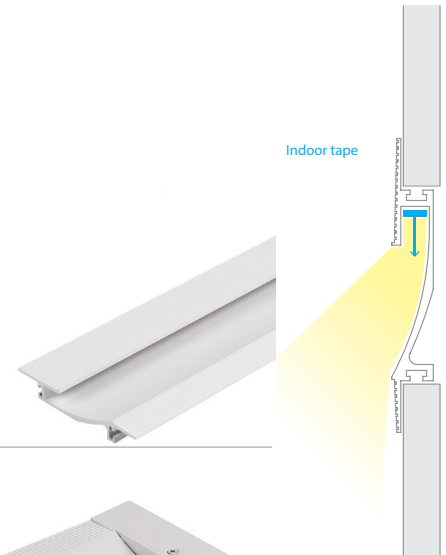
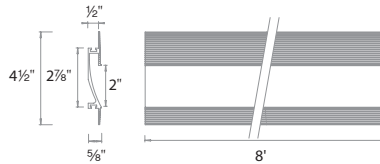

Power feed **LED-T-RBOX2-WT**

The end cap may be placed on either side
 Hanger bars may be installed on any side of the wiring box

Includes: 1 wiring box
 2 hanger bars
 2 five-pin adapters
 2 end caps (left and right)
 2 channel connectors
 1 counter sink bit
 1 drill bit

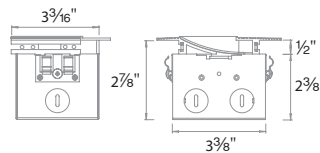
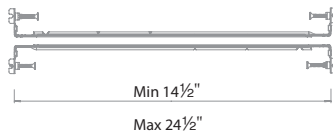

Indirect Recessed Channel

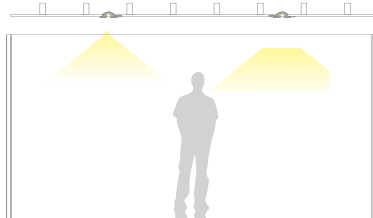

Linear channel can be field cut
 Accommodates up to four runs of indoor tape
 Dense foam insert to be removed in installation after spackling
 Allows option to use different color tape in one channel and switch them separately

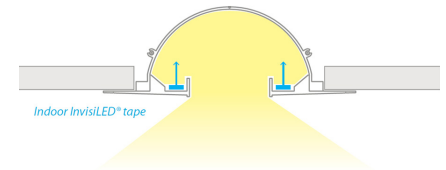

8ft Linear Channel **LED-T-RCH3-WT**

Includes: 10 perforated metal sheets
 2 channel connectors

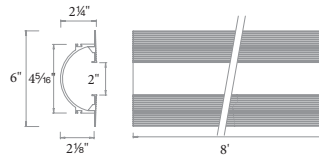

Power feed **LED-T-RBOX3-WT**

The end cap may be placed on either side
 Hanger bars may be installed on any side of the wiring box

Includes: 1 wiring box
 2 hanger bars
 4 five-pin adapters
 1 end cap
 2 channel connectors
 1 counter sink drill bit
 1 drill bit

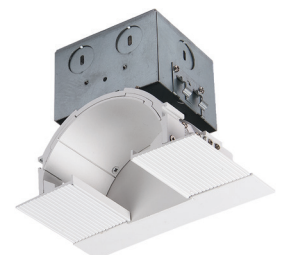
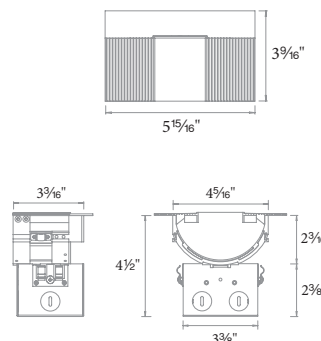
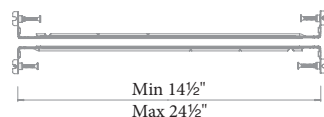

wacighting.com

Phone (800) 526.2588

Fax (800) 526.2585

Headquarters, East Manufacturing Facility

44 Harbor Park Drive

Port Washington, NY 11050

South East Manufacturing Facility

1600 Distribution Ct

Lithia Springs, GA 30122

Central Manufacturing Facility

1700 South J Elmer Freeway, Ste 100

Cedar Hill, TX 75104

West Manufacturing Facility

1750 S Archibald Ave

Ontario, CA 91761