

BASICS

LED Tape

WAC LIMITED

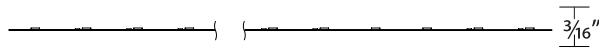
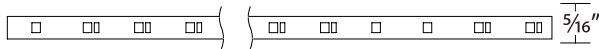

Fixture Type:

Catalog Number:

Project:

Location:

PRODUCT DESCRIPTION

Flexible, customizable, with a low profile. Basics LED Tape delivers precision and performance with five white color temperatures from warm 2700K to cool 5000 Kelvin. Smooth robust illumination deployed from evenly placed LEDs for cove, accent and task lighting applications. Strong 3M adhesive bond for easy installation. Seamless and scalable to 40 foot lengths. Cuttable in the field. Closet rated.

FEATURES

- Damp location listed
- Title 24 Compliant
- UL/cUL listed
- Available in convenient spools up to 100ft
- Cut and securely reconnect with ease
- May be cut every 4 inches
- Good color rendering
- Suitable for installation in a clothes closet
- 50,000 hour rated life
- 5 year WAC Lighting product warranty

SPECIFICATIONS

- Construction:** Flexible strip light
- Cutting Interval:** 4"
- Input:** 24VDC
- Lumens:** Up to 200 lm/ft
- Max Run:** Refer to ordering table
- CRI:** 90
- McAdams Steps:** 3
- Color Temp:** 2700K / 3000K / 3500K / 4000K / 5000K
- Rated Life:** 50,000 hours
- Operating Temp:** -4°F to 104°F (-20°C to 40°C)
- Standards:** UL & cUL listed, Damp Location listed, Title 24 Compliant
- Max Run:**

Total Length of Lead Wire Between Power Supply to Tape	Max Run Length	
	Basics 100	Basics 200
6FT (Comes Standard with Power Supply)	40 ft	40 ft
12FT	40 ft	40 ft
18FT	40 ft	28 ft
24FT	40 ft	20 ft
30FT	33 ft	17 ft
40FT	25 ft	13 ft

ORDER NUMBER – TAPE SELECTION

System	Max Run	Power	Length	Color Temp	Color
T24-BS1	100+lm/ft (Refer to above table)	1.2W/ft	15	27 2700K 30 3000K 35 3500K 40 4000K 50 5000K	WT
			40		
			100		
T24-BS2	200+lm/ft (Refer to above table)	2.4W/ft			

T24-BS1-__ - __WT

Example: **T24-BS1-15-27WT**

wacighting.com
Phone (800) 526.2588
Fax (800) 526.2585

Headquarters/Eastern Distribution Center
44 Harbor Park Drive
Port Washington, NY 11050



Central Distribution Center
1600 Distribution Ct
Lithia Springs, GA 30122

Western Distribution Center
1750 Archibald Avenue
Ontario, CA 91760









BASICS

Power Supplies and Accessories

Class 2 Power Supply (Required)

	Model	Input	Output	Dimming	
	EN-BT60-24	120VAC	24VDC 60W	ELV 100% - 10%	6 1/2" x 2 1/16" x 1 1/4" 6 ft. Output lead wires
	EN-BT96-24	120VAC	24VDC 96W	ELV 100% - 10%	
	PS-24DC-U60R-BT	120V-277VAC	24VDC 60W	ELV/ TRIAC	6 13/16" x 3 5/8" x 1"
	PS-24DC-U96R-BT	120V-277VAC	24VDC 96W	ELV/ TRIAC	8 1/16" x 3 7/8" x 1 9/16"

Accessories

Tape to Tape Connector		T24-BS-MM-CL	10 pcs	Clear	Connects tape sections
Tape to Tape Corner Connector		T24-BS-L-CL	2 pcs	Clear	Connects tape sections
Power to Tape Connector		T24-BS-PM-CL	10 pcs	Clear	Connects power feed to tape section
Flex Y Connector		T24-BS-Y-WT T24-BS-Y-BK	1 pc	White Black	Connects tape sections and power feed, Includes LED-T-B
Flex X Connector		T24-BS-X-WT T24-BS-X-BK	1 pc	White Black	Connects tape sections and power feed, Includes LED-T-B
Low Voltage Wiring Box		LED-T-B		White	Neatly house connections for up to 2 wires
Joiner Cable		T24-BS-IC-002 T24-BS-IC-006 T24-BS-IC-012 T24-BS-IC-036 T24-BS-IC-072	2 inches 6 inches 1 foot 3 feet 6 feet	-WT White -BK Black	Extends distance between tape sections
Extension Cable		T24-BS-EX2-072 T24-BS-EX2-144 T24-BS-EX2-240 T24-BS-EX2-480	6 feet 12 feet 20 feet 40 feet	-WT White -BK Black	Extends distance between tape sections and power supply (Includes a LED-T-B & screw driver)
Plastic Mounting Clip		T24-BS-CL1	10 pcs	Clear	For installation on non-flat surfaces. Include: 10 pcs plastic mounting clips and 10 pcs screws.

BASICS

Indoor Aluminum Channels

WAC LIMITED



Aluminum Channel **LED-T-CH** 5 feet
Additional End Caps **LED-T-CH-EC** 2 pcs

*Diffuses light from InvisiLED® tape
 Includes a diffuser, two end caps, and five screws*



Deep Aluminum Channel **LED-T-CH1** 5 feet
Additional End Cap **LED-T-CH1-EC** 2 pcs

*Eliminates visible hot spots
 Includes a diffuser, two end caps, and five screws*



45° Angled Aluminum Channel **LED-T-CH2** 5 feet
Additional End Caps **LED-T-CH2-EC** 2 pcs

Includes a diffuser, two end caps, and five screws



Deep Aluminum Channel - Flood 54° Beam Angle **LED-T-CH3-FL** 5 feet
Additional End Cap **LED-T-CH1-EC** 2 pcs

Eliminates visible hot spots / 54° beam angles



Deep Aluminum Channel - Spot 9° Beam Angle **LED-T-CH3-SP** 5 feet
Additional End Cap **LED-T-CH1-EC** 2 pcs

Eliminates visible hot spots / 9° beam angles



Deep Aluminum Channel - Wide Flood 84° Beam Angle **LED-T-CH3-WF** 5 feet
Additional End Cap **LED-T-CH1-EC** 2 pcs

Eliminates visible hot spots / 84° beam angles



Fixed Angle Channel Clip **LED-T-CL3-PT**

Includes 2 pieces, 4 screws. Use to mount Aluminum Channel

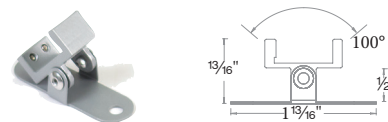

Adjustable Channel Clip **LED-T-CL2-PT**

Includes 2 pieces, 4 screws. Used to mount Aluminum Channel. Adjusts 50° from center either way

INDOOR MOUNTING ACCESSORIES



Aluminum Retrofit Channel **LED-T-RC** 3 feet

Can be bent to create fixed curves or used as a glare shield

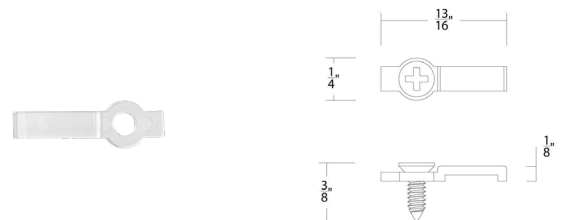

Plastic Mounting Clip **T24-BS-CL1** Clear

*For installation on non-flat surfaces
 Includes: 10 pcs plastic mounting clips and 10 pcs screws*

BASICS

Symmetrical Recessed Channel

WAC LIMITED

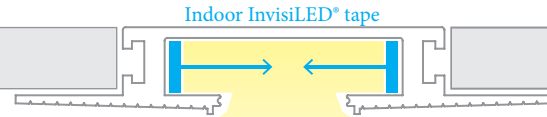

- Installs within $\frac{5}{8}$ " drywall depth
- Linear channel can be field cut
- Accommodates either one or two runs of InvisiLED® indoor tape
- Includes a translucent white acrylic diffuser
- Dense foam insert to be removed in installation after spackling

8ft Linear Channel

LED-T-RCH1-WT

- Includes: 1 diffuser
8 perforated metal sheets

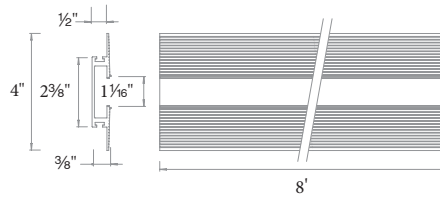

Power Feed

LED-T-RBOX1-WT

- The end cap may be placed on either side
Hanger bars may be installed on any side of the wiring box

- Kit includes: 1 wiring box
2 hanger bars
4 five-pin InvisiLED® adapters
2 end cap
1 diffuser
2 channel connector
1 counter sink drill bit
1 drill bit
1 installation tool

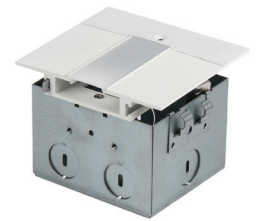
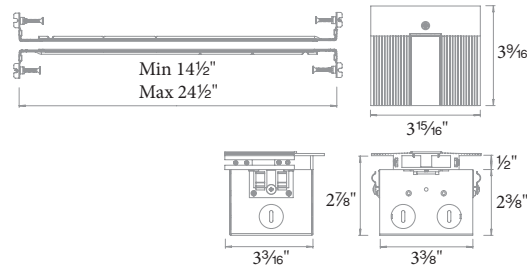

Lateral Corner

LED-T-CTC1-WT

- Includes: Diffuser
2 channel connectors
2 perforated metal sheets

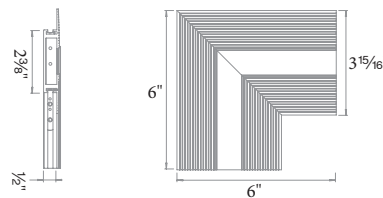

Perpendicular Corner

LED-T-WTC1-WT

- Transitions between walls or wall to ceiling

- Includes: Diffuser
2 channel connectors
2 perforated metal sheets

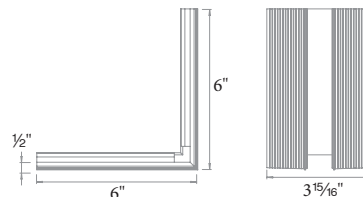

Outside Corner

LED-T-WTW1-WT

- Transitions around columns, bump outs, or soffits

- Includes: Diffuser
2 channel connectors
2 perforated metal sheets

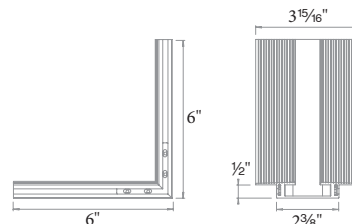

BASICS

Asymmetrical Recessed Channel



Installs within 5/8" drywall depth
 Linear channel can be field cut
 Accommodates one run of InvisiLED® indoor tape
 Dense foam insert to be removed in installation after spackling
 Recommended installation within 15 inches of surface to be illuminated

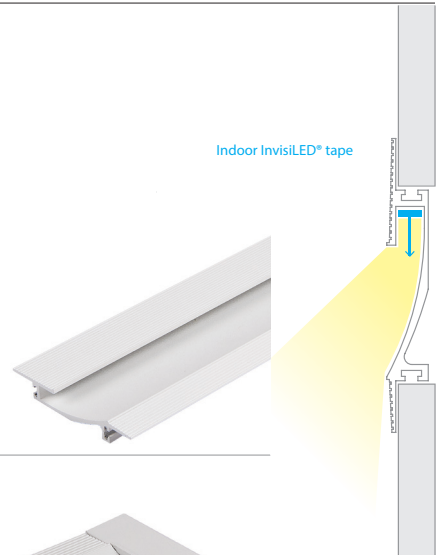

8ft Linear Channel **LED-T-RCH2-WT**

Includes: 8 perforated metal sheets
 2 channel connectors

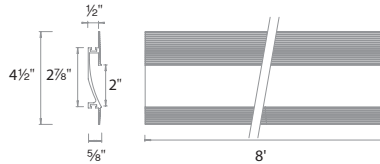

Power feed **LED-T-RBOX2-WT**

The end cap may be placed on either side
 Hanger bars may be installed on any side of the wiring box

Includes: 1 wiring box
 2 hanger bars
 2 five-pin InvisiLED® adapters
 2 end caps (left and right)
 2 channel connectors
 1 counter sink bit
 1 drill bit

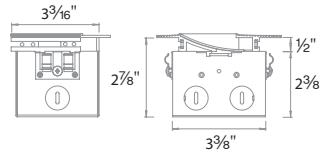
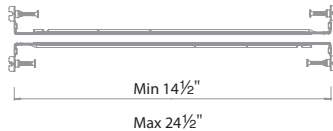

Indirect Recessed Channel

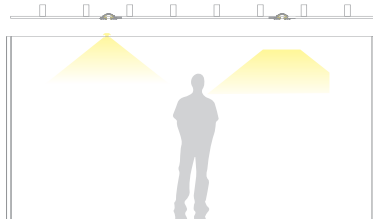

Linear channel can be field cut
 Accommodates up to four runs of InvisiLED® indoor tape
 Dense foam insert to be removed in installation after spackling
 Allows option to use different color InvisiLED® in one channel and switch them separately

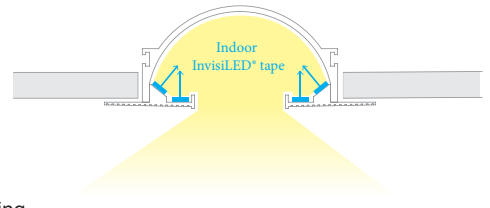

8ft Linear Channel **LED-T-RCH3-WT**

Includes: 10 perforated metal sheets
 2 channel connectors

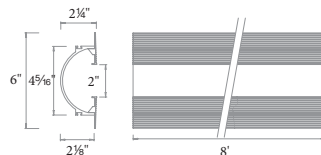

Power feed **LED-T-RBOX3-WT**

The end cap may be placed on either side
 Hanger bars may be installed on any side of the wiring box

Includes: 1 wiring box
 2 hanger bars
 4 five-pin InvisiLED® adapters
 1 end cap
 2 channel connectors
 1 counter sink drill bit
 1 drill bit

