

# InvisiLED® DIM-TO-WARM

## Dim-To-Warm Tape

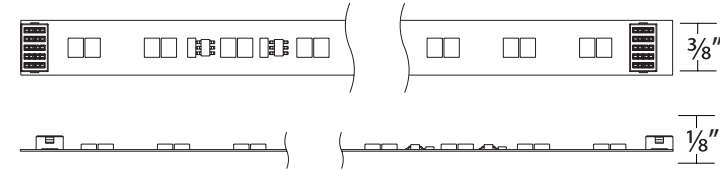
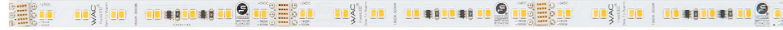

Fixture Type:

Catalog Number:

Project: \_\_\_\_\_

Location: \_\_\_\_\_

### PRODUCT DESCRIPTION

Using Dim-to-Warm CCT technology, InvisiLED Tape is ideal for changing the mood of the space, whether it's a warm light for dining and entertaining or a cooler white light for bookkeeping and studying. Offering up to 300 lumens using just 3 Watts per foot, the Patent-pending InvisiLED Dim-to-Warm offers two versions-- ranging from 1800K to 3000K and 1800K to 3500K CCT. This allows the user to adjust and lock-in the CCT from 1800K to 2200K (lower levels) onboard the remote LED driver.

### FEATURES

- May be cut and easily reconnected every 4 inches
- Select and choose desirable lowest CCT among 1800K/1900K/2000K/2100K/2200K as you gradually dim the light from either 3000K or 3500K to warmer color temperature
- Equal brightness for an entire light strip
- Strong adhesive bonding with the 3M adhesive VHB
- Gold plated connector protects from corrosion, heat, and ensures a reliable connection
- 100 ft max distance between the power supply and beginning of InvisiLED® Dim-To-Warm
- Closet Rated options (T24-WD2)

### SPECIFICATIONS

<b>Construction:</b>	Flexible strip light
<b>Cutting Interval:</b>	4"
<b>Input:</b>	24VDC
<b>Lumens:</b>	200/300 lm/ft
<b>Max Run:</b>	Refer to ordering table
<b>Dimming:</b>	ELV, 0-10V
<b>CRI:</b>	90
<b>McAdams Steps:</b>	3
<b>Color Temp:</b>	1800K/1900K/2000K/2100K/2200K - 3000K
<b>Rated Life:</b>	50,000 hours
<b>Operating Temp:</b>	-4°F to 104°F (-20°C to 40°C)
<b>Standards:</b>	UL & cUL listed, Damp Location listed, Title 24 Compliant

### TAPE SELECTIONS

System	Max Run	Power	Length (in feet)					Color Temp		Finish	
			01	05	10	20	40				
<b>T24-WD2</b> 200+lm/ft	40 ft	2.4W/ft	01	05	10	20	40	<b>1830</b>	1800K - 3000K	<b>WT</b>	White
<b>T24-WD3</b> 300+lm/ft	30 ft	3.0W/ft	01	05	10	20	30	<b>1835</b>	1800K - 3500K		

Example: **T24-WD2-05-1835WT**

wacighting.com

Phone (800) 526.2588  
Fax (800) 526.2585

**Headquarters, East Manufacturing Facility**

44 Harbor Park Drive  
Port Washington, NY 11050

**South East Manufacturing Facility**

1600 Distribution Ct  
Lithia Springs, GA 30122

**Central Manufacturing Facility**

1700 South J Elmer Freeway, Ste 100  
Cedar Hill, TX 75104









**West Manufacturing Facility**

1750 S Archibald Ave  
Ontario, CA 91761

# InvisiLED® DIM-TO-WARM

## Power Supplies and Accessories



	MODEL	Finish			
	T24-MM-WT	White	Tape to Tape Connector Connects tape sections		
	T24-TI-WT	White	Tape to Tape T Connector Connects tape sections		
	T24-XI-WT	White	Tape to Tape X Connector Connects power feed to tape section		
	T24-LI-WT	White	Tape to Tape L Connector Connects tape sections		
	T24-FF-WT	White	Joiner Cable Extender Connects joiner cable to joiner cable, female on both sides		
	T24-Y-WT T24-Y-BK	White Black	Flex Tape to Tape Y Connector Connects tape sections		
	T24-X-WT T24-X-BK	White Black	Flex Tape to Tape X Connector Connects tape sections		
	T24-IC-002 T24-IC-006 T24-IC-012 T24-IC-036 T24-IC-072 T24-IC-144 T24-IC-240	WT White BK Black	In Wall Rated Joiner Cable Connects tape sections, 2 male ends	2 in 6 in 1 ft 3 ft 6 ft 12 ft 20 ft	Example: <b>T24-IC-002-WT</b>
	T24-EX3-072 T24-EX3-144 T24-EX3-240 T24-EX3-1200	WT White BK Black	In Wall Rated Extension Cable Extends distance between a hard wire power supply or a wiring box to a tape section	6 ft 12 ft 20 ft 100 ft	Example: <b>T24-EX3-072-WT</b>
	T24-CT-CL1	Clear	Plastic Mounting Clip For installation on non-flat surfaces Include 10 pcs plastic mounting clip and 10 screws		
	IR-96-24VDC-CCT-WT IR-96-24VDC-CCT-BK	White Black	IR Sensor IR (Infrared) sensor switch works by turning the light on when it becomes unobstructed		

## Power Supply for InvisiLED Dim-To-Warm

	MODEL	Input	Output	Dimming	
	PS-24DC-U60R-WD-SM PS-24DC-U96R-WD-SM	120-277VAC	24VDC 60W 24VDC 96W	ELV / 0-10V	7 11/16" x 3 7/8" x 1 3/8" > 0.9 pf Overload and short circuit protection Includes 6ft lead wire with connector

wacighting.com  
Phone (800) 526.2588  
Fax (800) 526.2585

Headquarters/Eastern Distribution Center  
44 Harbor Park Drive  
Port Washington, NY 11050

Central Distribution Center  
1600 Distribution Ct  
Lithia Springs, GA 30122

Western Distribution Center  
1750 Archibald Avenue  
Ontario, CA 91761

# InvisiLED® DIM-TO-WARM

## Indoor Aluminum Channels

# WAC



**Aluminum Channel**  
Additional End Caps

**LED-T-CH** 5 feet  
**LED-T-CH-EC** 2 pcs

*Diffuses light from InvisiLED® tape  
Includes a diffuser, two end caps, and five screws*



**Deep Aluminum Channel**  
Additional End Caps

**LED-T-CH1** 5 feet  
**LED-T-CH1-EC** 2 pcs

*Eliminates visible hot spots  
Includes a diffuser, two end caps, and five screws*



**45° Angled Aluminum Channel**  
Additional End Caps

**LED-T-CH2** 5 feet  
**LED-T-CH2-EC** 2 pcs

*Includes a diffuser, two end caps, and five screws*



**Deep Aluminum Channel - Flood 54° Beam Angle**  
Additional End Caps

**LED-T-CH3-FL** 5 feet  
**LED-T-CH1-EC** 2 pcs

*Eliminates visible hot spots / 54° beam angles*



**Deep Aluminum Channel - Spot 9° Beam Angle**  
Additional End Caps

**LED-T-CH3-SP** 5 feet  
**LED-T-CH1-EC** 2 pcs

*Eliminates visible hot spots / 9° beam angles*



**Deep Aluminum Channel - Wide Flood 84° Beam Angle**  
Additional End Caps

**LED-T-CH3-WF** 5 feet  
**LED-T-CH1-EC** 2 pcs

*Eliminates visible hot spots / 84° beam angles*

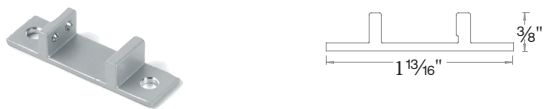

**Fixed Angle Channel Clip** **LED-T-CL3-PT**

*Includes 2 pieces, 4 screws. Use to mount Aluminum Channel*

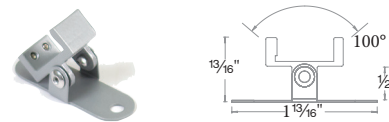

**Adjustable Channel Clip** **LED-T-CL2-PT**

*Deep Aluminum Channel, 45° Angled Aluminum Channel*

## INDOOR MOUNTING ACCESSORIES



**Aluminum Retrofit Channel** **LED-T-RC** 3 feet

*Can be bent to create fixed curves or used as a glare shield*

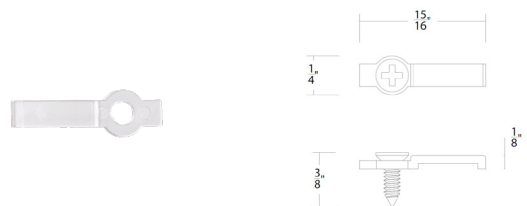

**Plastic Mounting Clip** **T24-CT-CL1** Clear

*For installation on non-flat surfaces  
Includes: 10 pcs plastic mounting clips and 10 pcs screws*

# InvisiLED® DIM-TO-WARM

## Symmetrical Recessed Channel

# WAC

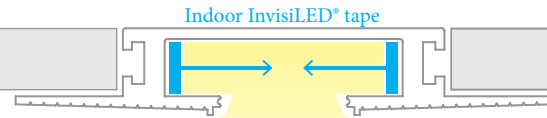

- Installs within  $\frac{5}{8}$ " drywall depth
- Linear channel can be field cut
- Accommodates either one or two runs of InvisiLED® indoor tape
- Includes a translucent white acrylic diffuser
- Dense foam insert to be removed in installation after spackling

### 8ft Linear Channel

#### LED-T-RCH1-WT

- Includes: 1 diffuser  
8 perforated metal sheets

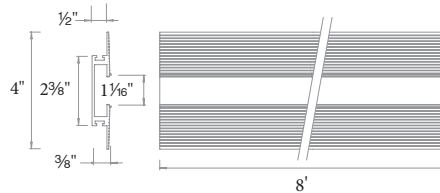

### Power Feed

#### LED-T-RBOX1-WT

- The end cap may be placed on either side  
Hanger bars may be installed on any side of the wiring box

- Kit includes: 1 wiring box  
2 hanger bars  
4 five-pin InvisiLED® adapters  
2 end caps  
1 diffuser  
2 channel connectors  
1 counter sink drill bit  
1 drill bit  
1 installation tool

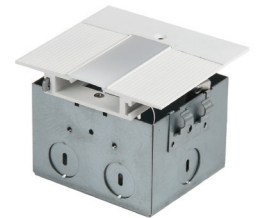
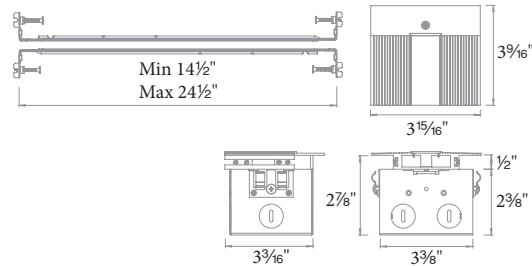

### Lateral Corner

#### LED-T-CTC1-WT

- Includes: Diffuser  
2 channel connectors  
2 perforated metal sheets

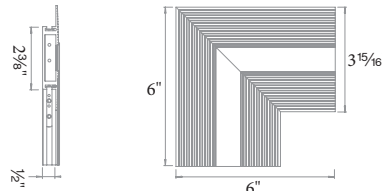

### Perpendicular Corner

#### LED-T-WTC1-WT

- Transitions between walls or wall to ceiling

- Includes: Diffuser  
2 channel connectors  
2 perforated metal sheets

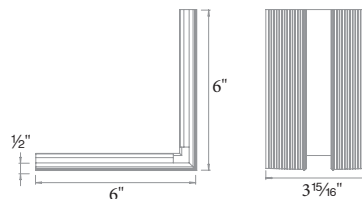

### Outside Corner

#### LED-T-WTW1-WT

- Transitions around columns, bump outs, or soffits

- Includes: Diffuser  
2 channel connectors  
2 perforated metal sheets

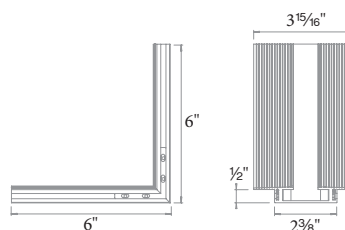

# INVISILED® DIM-TO-WARM

## Asymmetrical Recessed Channel

# WAC



Installs within 5/8" drywall depth  
 Linear channel can be field cut  
 Accommodates one run of InvisILED® indoor tape  
 Dense foam insert to be removed in installation after spackling  
 Recommended installation within 15 inches of surface to be illuminated

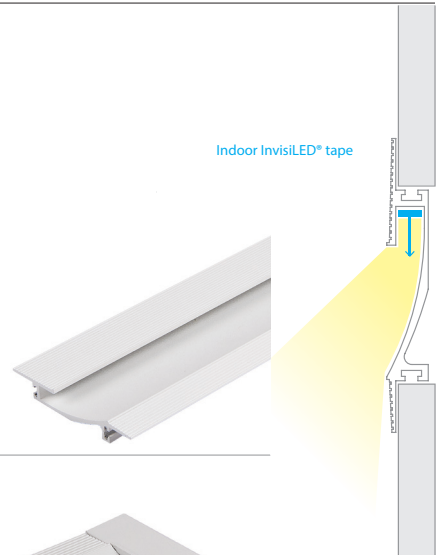

### 8ft Linear Channel **LED-T-RCH2-WT**

Includes: 8 perforated metal sheets  
 2 channel connectors

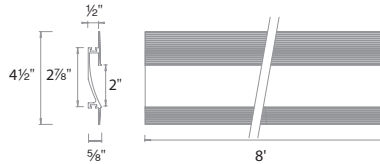

### Power Feed **LED-T-RBOX2-WT**

The end cap may be placed on either side  
 Hanger bars may be installed on any side of the wiring box

Includes: 1 wiring box  
 2 hanger bars  
 2 five-pin InvisILED® adapters  
 2 end caps (left and right)

2 channel connectors  
 1 counter sink bit  
 1 drill bit

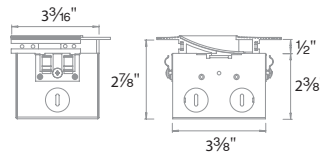
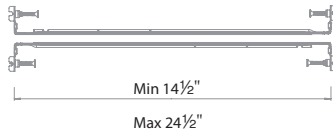

## Indirect Recessed Channel

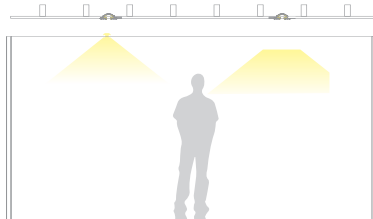

Linear channel can be field cut  
 Accommodates up to four runs of InvisILED® indoor tape  
 Dense foam insert to be removed in installation after spackling  
 Allows option to use different color InvisILED® in one channel and switch them separately

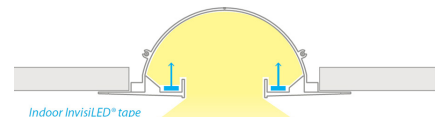

### 8ft Linear Channel **LED-T-RCH3-WT**

Includes: 10 perforated metal sheets  
 2 channel connectors

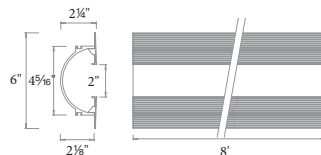

### Power Feed **LED-T-RBOX3-WT**

The end cap may be placed on either side  
 Hanger bars may be installed on any side of the wiring box

Includes: 1 wiring box  
 2 hanger bars  
 4 five-pin InvisILED® adapters  
 1 end cap

2 channel connectors  
 1 counter sink drill bit  
 1 drill bit

